



SR50 - EXTENSION RING

Description SR50G / B - 50mm Extension Ring

Finish BZP (G) or Black Enamel (B)

Material Steel

Packaging Packed in qty 10

Additional Notes

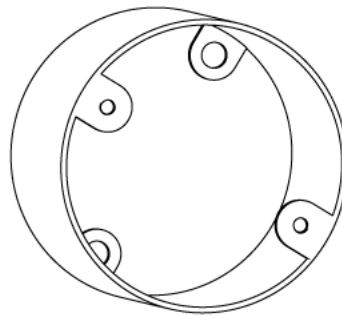
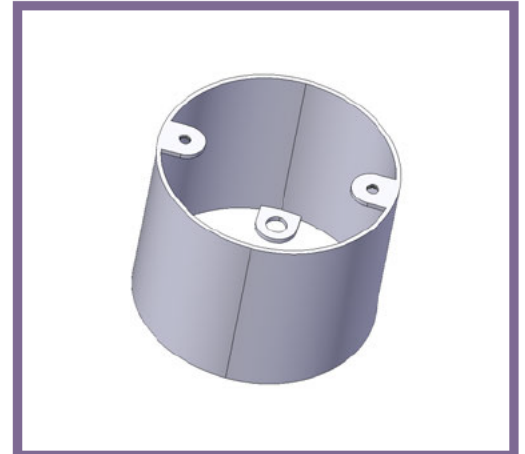

Isometric view

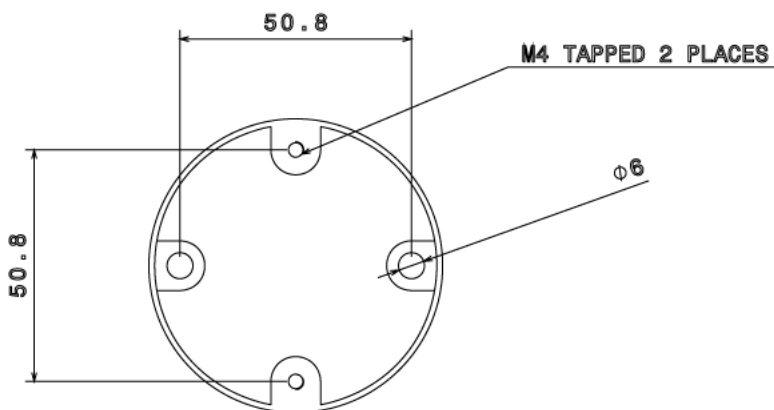

Top view

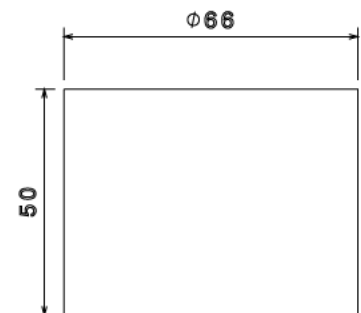

Side view

All measurements in mm unless otherwise stated



SRG33 - ADAPTABLE BOX GASKET

Description	SRG33 - 3" X 3" Adaptable Box Gasket
Finish	Black
Material	Rubber
Packaging	Packed in qty 10
Additional Notes	For use with 3" x 3" Adaptable Boxes to offer an IP54 rating

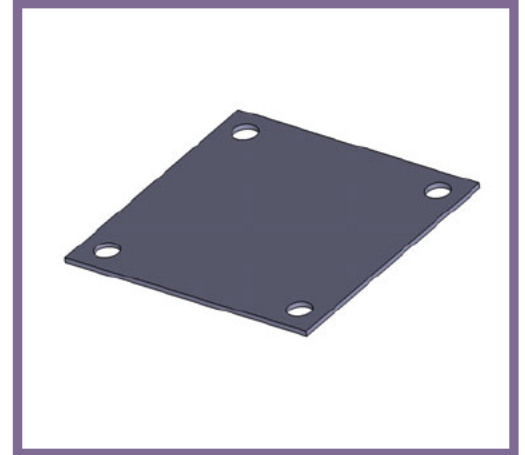

All measurements in mm unless otherwise stated



SRG44 - ADAPTABLE BOX GASKET

Description	SRG44 - 4" X 4" Adaptable Box Gasket
Finish	Black
Material	Rubber
Packaging	Packed in qty 10
Additional Notes	For use with 4" x 4" Adaptable Boxes to offer an IP54 rating

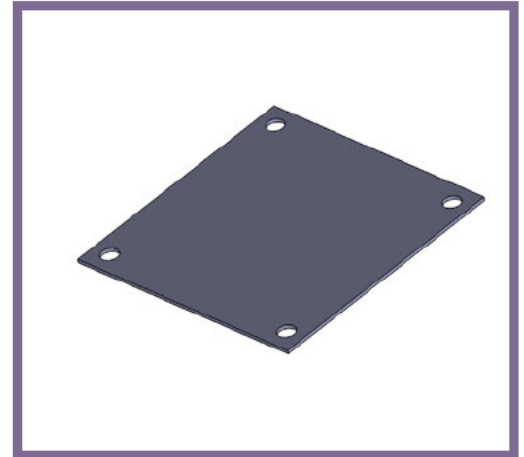

All measurements in mm unless otherwise stated



SRG66 - ADAPTABLE BOX GASKET

Description	SRG66 - 6" X 6" Adaptable Box Gasket
Finish	Black
Material	Rubber
Packaging	Packed in qty 10
Additional Notes	For use with 6" x 6" Adaptable Boxes to offer an IP54 rating

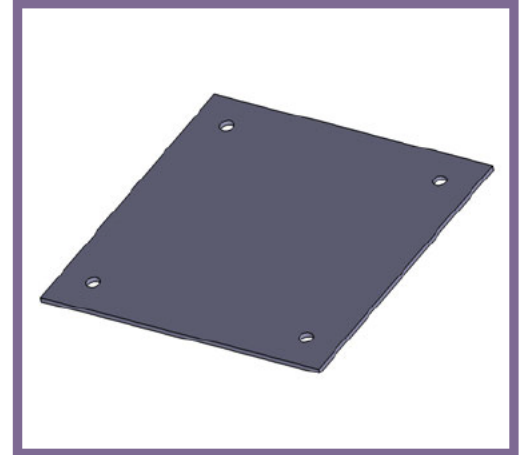

All measurements in mm unless otherwise stated