



PLN32 - PVC LOCKNUT -

Description PLN32W / B / R - PVC 32mm Locknut

Finish White (W) Black (B) Red (R)

Material PVC

Packaging Packed in qty 50

Additional Notes Manufactured to BS4607 part 1

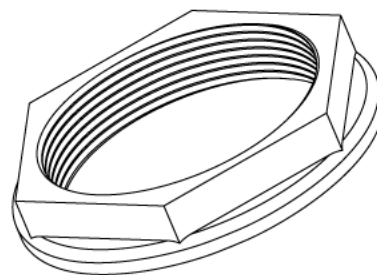
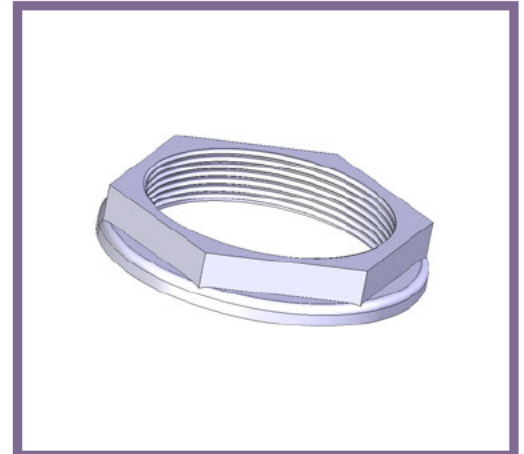

Isometric view

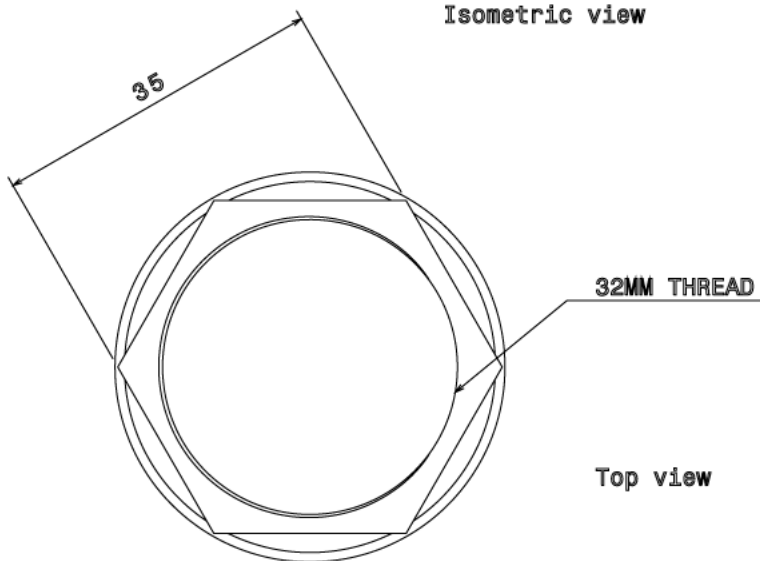

Top view



Side view

All measurements in mm unless otherwise stated