

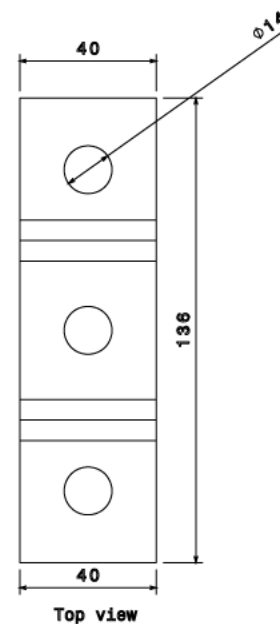

MP30 - CHANNEL BRACKET

Description	MP30 - 82mm U Bracket
Finish	Hot Dipped Galvanised
Material	Steel
Packaging	Packed in qty 10
Additional Notes	Compliant to LU Standard 1-085 (For use on surface & sub-surface locations)

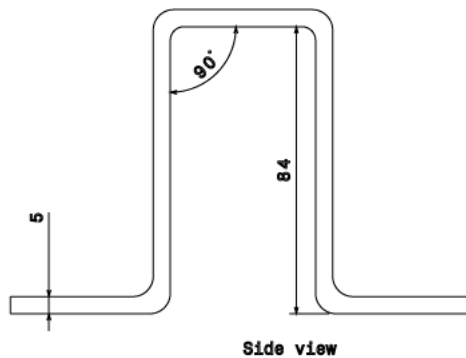
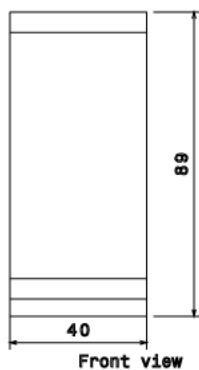
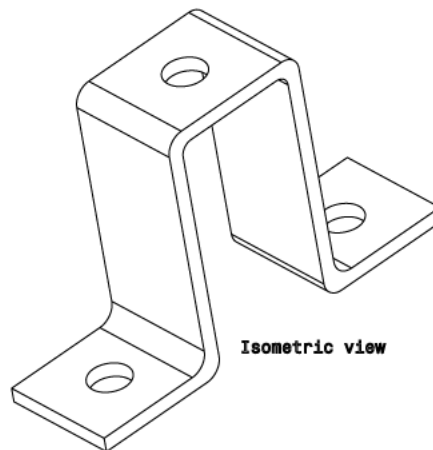
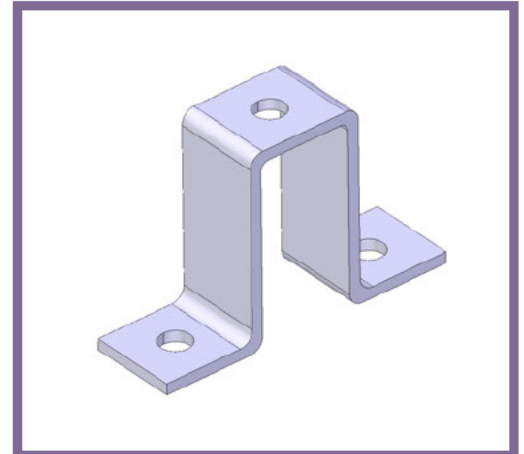

All measurements in mm unless otherwise stated