

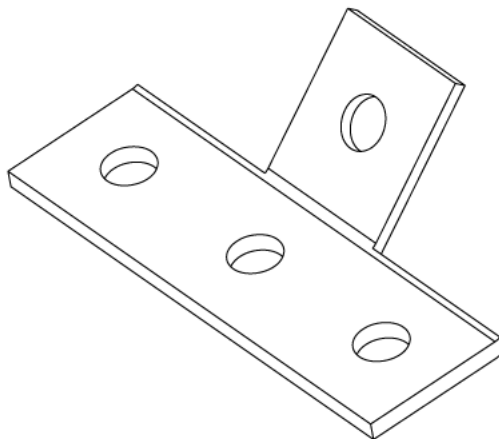

MP16 - CHANNEL BRACKET

Description	MP16 - 45° Tee Bracket
Finish	Hot Dipped Galvanised
Material	Steel
Packaging	Packed in qty 25
Additional Notes	Compliant to LU Standard 1-085 (For use on surface & sub-surface locations)

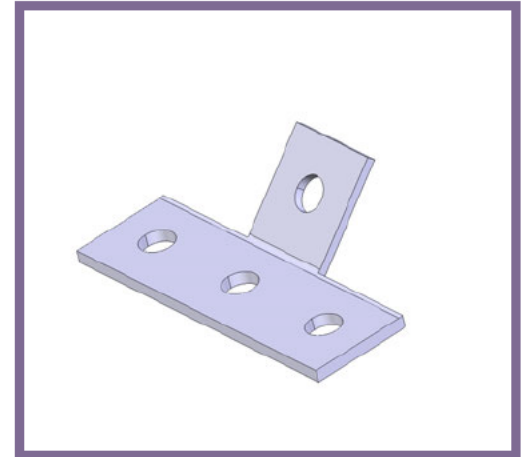

Isometric view

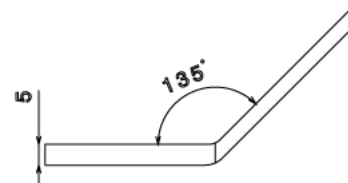

Side view

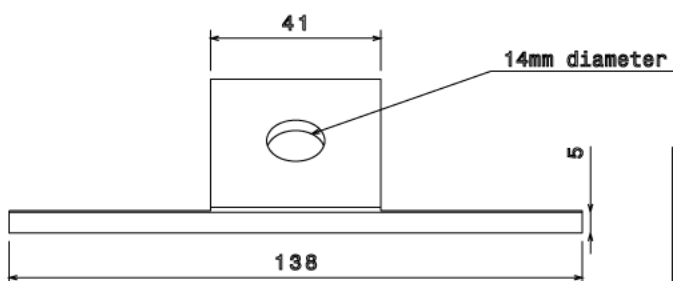

Front view

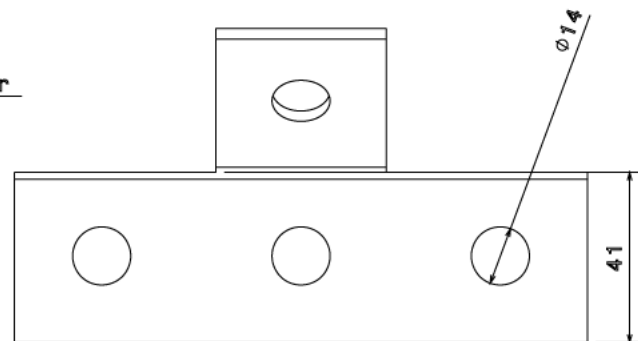

Top view

All measurements in mm unless otherwise stated