

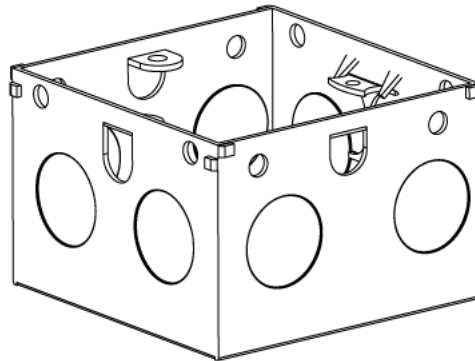

EWS7 - SWITCH & SOCKET BOX

Description	EWS7 - 47mm 1 Gang Switch & Socket Box
Finish	Pre Galvanised
Material	Sheet steel to comply with BS4670
Packaging	Packed in qty 10
Additional Notes	Comprises of Body and Earth Terminal with screw 3 fixed lugs and 1 adjustable lug , 20mm Knockouts Compliant To BS4662 & LU Standard 1-085 (For Use On Surface & Sub-Surface Locations)

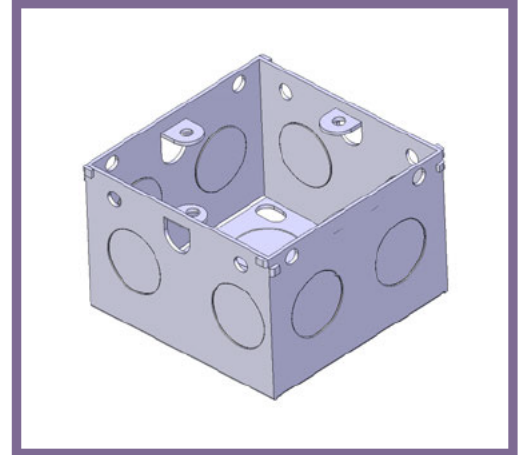

Isometric view

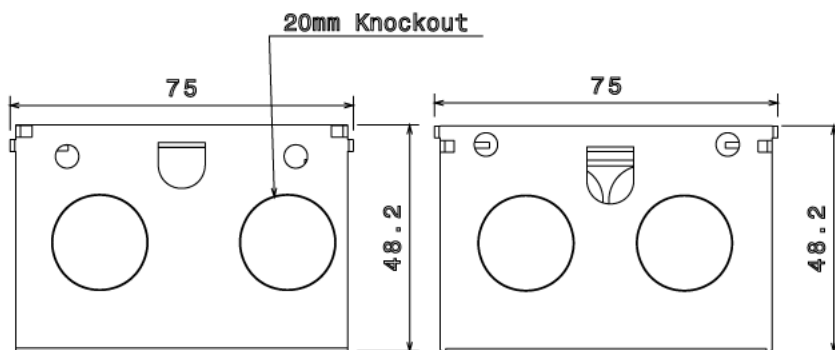

Front view

Side view

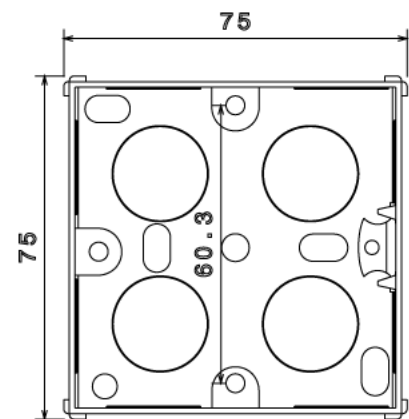

Top view

All measurements in mm unless otherwise stated