



## CN6 - EASYFIT CHANNEL NUT

**Description** CN6 - M6 Easyfit Channel Nut c/w Nylon Captive Assembly

**Finish** BZP - Nut only

**Material** Nut - Steel / Captive Assembly - Nylon 6

**Packaging** Packed in qty 100

**Additional Notes** For use with 21mm and 41mm Depth Channel  
Produced to comply with the requirements of BS6946 Metal Channel Support Systems  
RoHS Compliant & Halogen Free

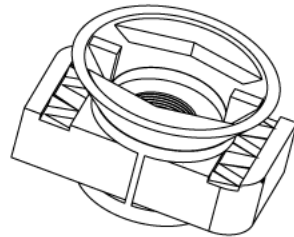
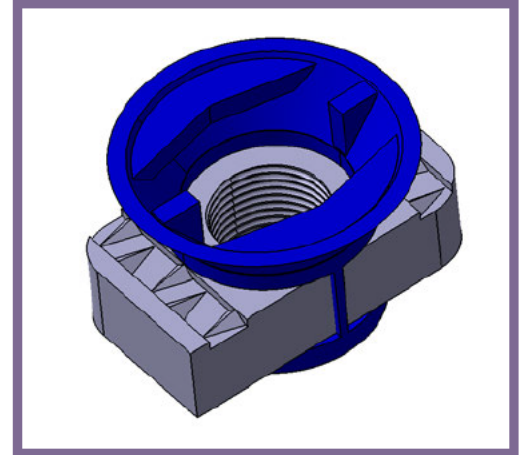

Isometric view

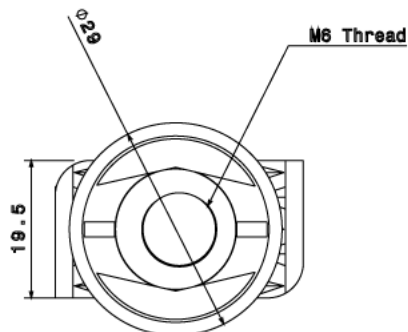

Top View

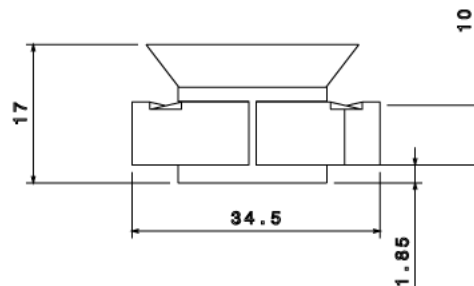

Side view

All measurements in mm unless otherwise stated