

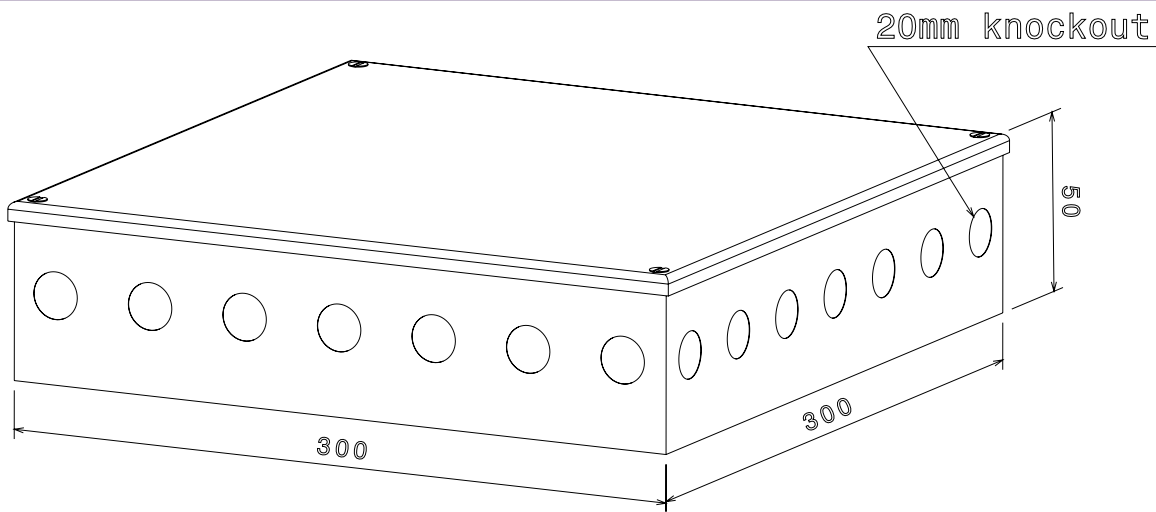

AB22G/K - ADAPTABLE BOX - KNOCK OUT

Description	AB22G/K - 300 x 300 x 50mm (12 x 12 x 2") Adaptable Box - Knock Out
Finish	Pre Galvanised Sheet Steel
Material	Galvanised Steel Sheet
Packaging	Packed in qty 2 (Can be purchased individually)
Additional Notes	Comprises of Body, Flanged Cover and M5 x 10mm Lid Fixing Screws Knock outs - 7 x 20mm on each face Compliant To LU Standard 1-085 (For Use On Surface & Sub-Surface Locations)

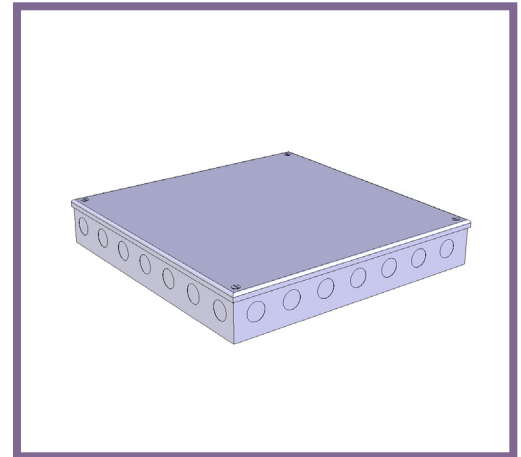

Isometric view

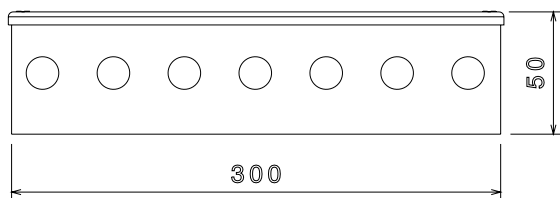

Front view

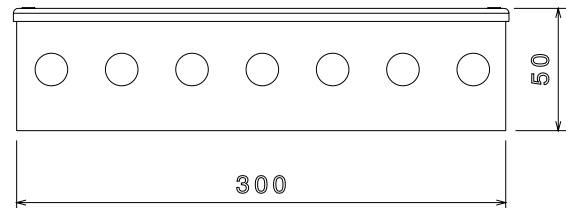

Side view

All measurements in mm unless otherwise stated