



## AB16G - ADAPTABLE BOX - PLAIN

**Description** AB16G - 225 x 150 x 50mm (9 x 6 x 2") Adaptable Box - Plain

**Finish** Pre Galvanised Sheet Steel

**Material** Galvanised Steel Sheet

**Packaging** Packed in qty 5 ( Can be purchased individually)

**Additional Notes** Comprises of Body, Flanged Cover and M5 x 10mm Lid Fixing Screws  
Plain sides (This product is also available with pre-cut Knockouts)  
Compliant To LU Standard 1-085 ( For Use On Surface & Sub-Surface Locations)

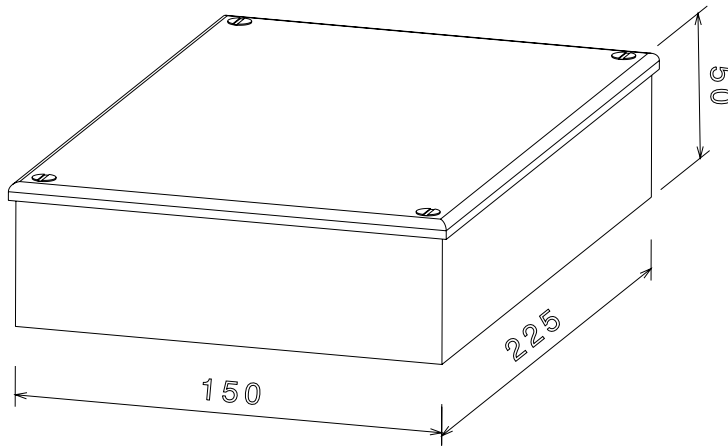
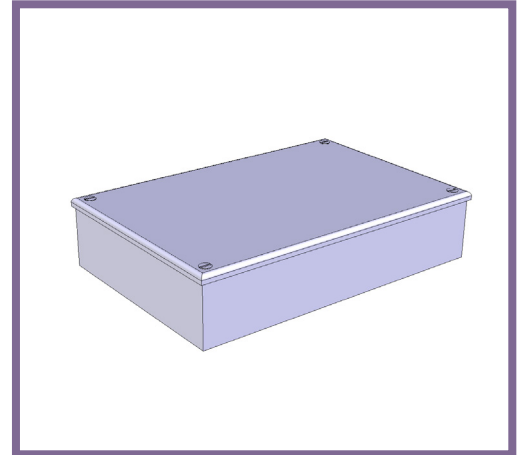

Isometric view

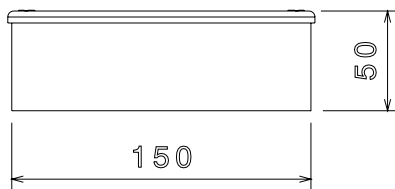

Front view

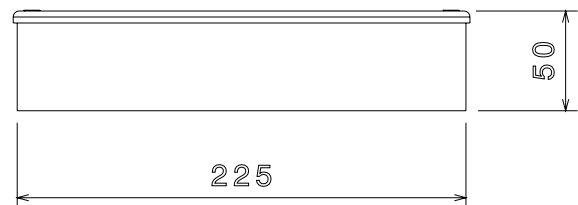

Side view

All measurements in mm unless otherwise stated