

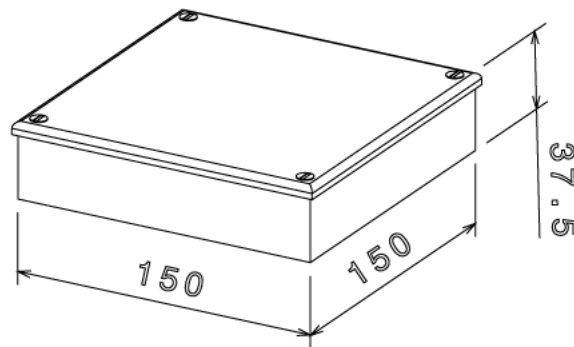

AB12G - ADAPTABLE BOX - PLAIN

Description	AB12G - 150 x 150 x 37.5mm (6 x 6 x 1.5") Adaptable Box - Plain
Finish	Pre Galvanised Sheet Steel
Material	1.2mm Nominal Galvanised Steel Sheet to BS EN 50142 & 3
Packaging	Packed in qty 5 (Can be purchased individually)
Additional Notes	Comprises of Body, Flanged Cover and 4 Lid Fixing Screws Plain sides (This product is also available with pre-cut Knockouts) Compliant To LU Standard 1-085 (For Use On Surface & Sub-Surface Locations)

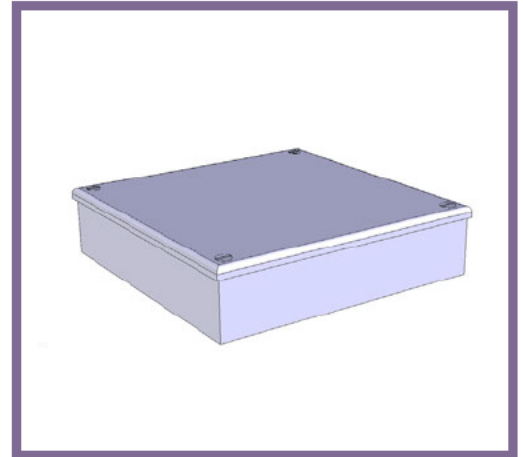

Isometric view

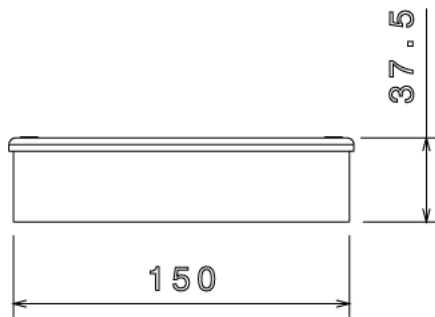

Front view

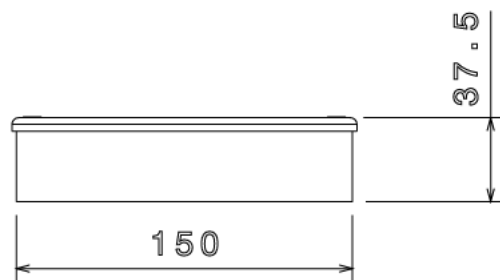

Side view

All measurements in mm unless otherwise stated