



AB08G - ADAPTABLE BOX - PLAIN

Description AB08G - 150 x 75 x 50mm (6 x 3 x 2") Adaptable Box - Plain

Finish Pre Galvanised Sheet Steel

Material Galvanised Steel Sheet

Packaging Packed in qty 5 (Can be purchased individually)

Additional Notes Comprises of Body, Flanged Cover and M5 x 10mm Lid Fixing Screws
Plain sides (This product is also available with pre-cut Knockouts)
Compliant To LU Standard 1-085 (For Use On Surface & Sub-Surface Locations)

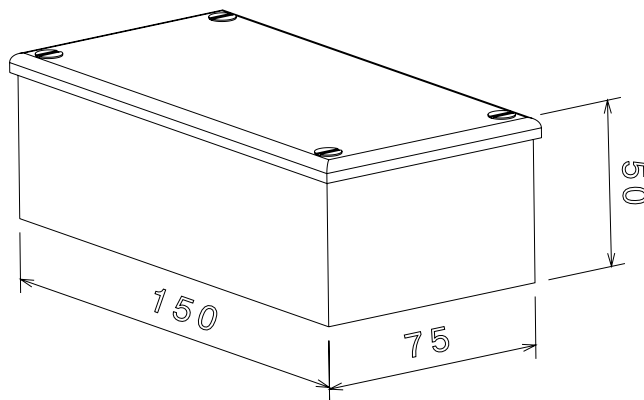
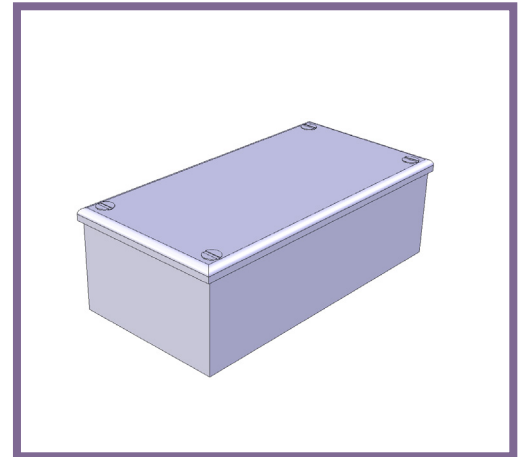

Isometric view

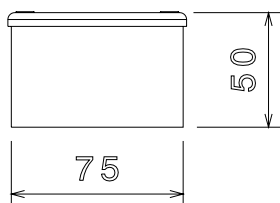

Front view

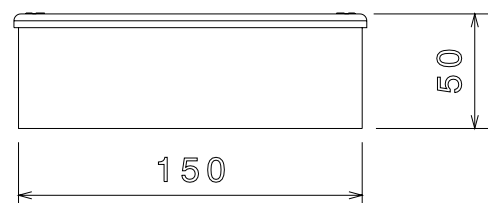

Side view

All measurements in mm unless otherwise stated